

For the operator/for the heating engineer

Operating and Installation Manual
VRC 430



Weather compensator

VRC 430

For the operator

Operating Manual VRC 430

Weather compensator

VRC 430

Contents

Appliance features.....	4	4.3	Operating concept	8	
Application	4	4.3.1	Show various display screens.....	9	
Product features.....	4	4.3.2	Changing parameters.....	9	
1	Notes on the documentation.....	5	4.3.3	Operation in the simplified basic display.....	11
1.1	Storing of the documents	5	4.4	The period of validity for new control system target values.....	12
1.2	Symbols used	5	4.5	Operator level, Expert technician level.....	13
1.3	Applicability of the manual.....	5	4.6	Screens in the operating level for the operator.....	13
1.4	CE label.....	5	4.7	Changing the displays (examples).....	15
2	Safety	5	4.7.1	Entering time programmes (example for heating circuit)	15
3	Notes on operation	6	4.7.2	Programming holiday periods	16
3.1	Intended use.....	6	4.7.3	Entering parameters for the heating circuit	17
3.2	Environmental conditions	6	4.7.4	Entering parameters for hot water generation.....	18
3.3	Care	6	4.7.5	Renaming the heating components	18
3.4	Vaillant warranty.....	6	5	Status and error messages.....	19
3.5	Recycling and disposal	6			
4	Operation	7			
4.1	Overview operating and display front	7			
4.2	Overview of the display (display field)	8			

Appliance features

Application

The VRC 430 is a weather compensator controller for heating and generating hot water.

"Weather compensator" means: at low external temperatures the VRC 430 provides more heating output, and at higher external temperatures lower heating output. The outside temperature is measured by a separate outdoor sensor, and the results are transmitted to the VRC 430.

The room temperature is based only on your preset values. The system compensates for the effect of the external temperature.

You can use the VRC 430 to set different room target temperatures - for different times of the day and for different days of the week.

In automatic mode, the VRC 430 controls your heating according to these settings (see Fig. 0.1).

With the VRT 430 you can also control times for heating and hot water generation.

The VRC 430 can also be used to control the following accessory components:

- Circulation pump for hot water generation in conjunction with a multi-functional module 2 of 7
- Conventional domestic hot water cylinder
- Vaillant layer hot water storage tank actoSTOR
- Second heating circuit using the Vaillant Mixer Module VR 61
- Solar unit using the Vaillant Solar Module VR 68

The VRC 430 can be operated with the Vaillant remote control VR 81.

The VRC 430 can form part of a new heating and hot water generation unit or can also be retro-fitted into an existing installation. The heating unit must have an eBUS interface.

eBUS is a communications standard for data exchange between heating technology components.

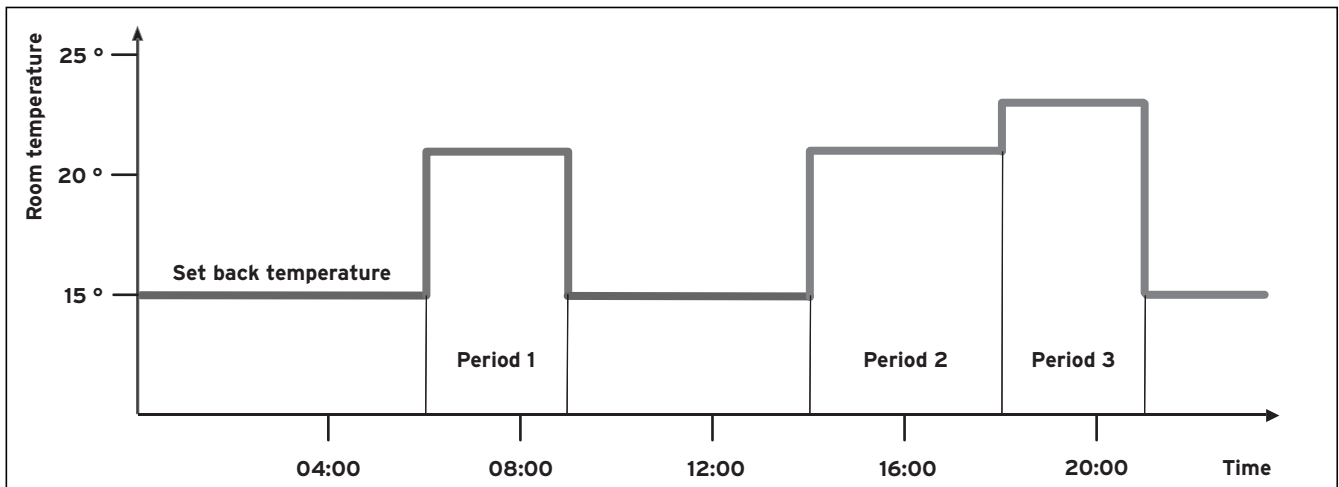

Fig. 0.1 Automatic heating operation: Example, setting the target room temperature for different times of day

Product features

- eBUS interface
- Data connection with a Vaillant heating unit via an eBUS line
- Illuminated graphical display (display field)
- Operation via both dials according to the Vaillant "turn and click" principle
- Direct fitting of the controller in the operating panel of the heating unit or separate wall mounting
- Equipped for operation with Vaillant diagnostics software vrDIALOG 810/2 and with the Vaillant Internet Communication System vrnetDIALOG, i.e. Remote diagnosis and settings

1 Notes on the documentation

The following information is intended to help you work through the documentation. Additional documents apply in combination with this operating manual.

We accept no liability for any damage caused by failure to observe these instructions.

Other applicable documents

- The installation instructions for the Vaillant controller VRC 430 (Section 2 of this document For the expert technician:
- The operating and installation manual for your heating system
- All instructions for accessory components

Glossary:

At the end of this document, in the appendix, you will find an explanation of technical terms and important functions listed in alphabetical order.

1.1 Storing of the documents

Please store this operating manual and all related documents in such a way that they are available whenever required.

1.2 Symbols used

Please observe the safety instructions in this manual when operating the unit.



Danger!
Danger of death by electrocution!



Danger!
Immediate risk of serious injury or death!



Caution!
Danger of burning and scalding!



Caution!
Potentially dangerous situation for the product and environment!



Note!
Useful information and instructions.

⇒ Symbol indicating a required task

1.3 Applicability of the manual

This operating manual applies exclusively to units with the following article number:

0020028520 VRC 430

The article number of your unit can be obtained from your expert technician.

1.4 CE label

The CE mark documents the fact that the Vaillant controller VRC 430 fulfils the fundamental requirements of the relevant guidelines.

2 Safety

The VRC 430 may only be installed by a suitably qualified expert technician. This engineer also assumes responsibility for properly installing and starting up the unit.



Caution!

Risk of being scalded by hot water!
At the draw-off locations for the hot water there is a danger of scalding at temperatures in excess of 60 °C. Young children and elderly persons can be in danger even at lower temperatures.

Select the set target temperature to prevent injury to all persons (see section 4.7.4).

Caution!

Risk of being scalded by hot water!
If your expert technician has activated the anti-legionella function for your domestic hot water cylinder, the hot water at certain draw-off points may reach temperatures above 60 °C.

Contact your technician to find out if this function has been activated, and if so, for which days and times.

3 Notes on operation

3 Notes on operation

3.1 Intended use

The VRC 430 weather compensator is a state-of-the-art appliance manufactured in accordance with recognised safety regulations.

However, damage and property may occur if the unit is used improperly or for a purpose other than the intended purpose.

The VRC 430 controller is designed as a weather compensator timer-controlled heating unit with or without hot water generation/circulation pump in conjunction with a Vaillant boiler with eBUS interface.

Operation with the following accessories is permitted:

- Circulation pump for hot water generation in conjunction with a multi-functional module 2 of 7
- Conventional domestic hot water cylinder
- Vaillant layer hot water storage tank actoSTOR
- Second heating circuit using the Vaillant Mixer Module VR 61
- Solar unit using the Vaillant Solar Module VR 68
- VR 81 remote control device

Any other or extended use is considered to be use other than intended. The manufacturer or supplier is not liable for any resulting damage. The owner alone bears any risk.

Intended use also includes observing the operating and installation instructions and all other applicable documents.

3.2 Environmental conditions

If the "thermostat" function is active and the VR 81 remote control unit is not connected, please ensure:

- the unit is not blocked by furniture or other obstacles.
- the radiator valves in the room in which the VRC 430 is fitted are fully open.

"room temperature compensation" means that the current room temperature is evaluated by the VRC 430 and taken into account in the control system.

Your expert technician will advise you whether the "room temperature compensation" is activated.

3.3 Care

Clean the enclosure of the VRC 430 with a damp cloth. Never use scouring or cleaning agents which could damage the operating elements or the display.

3.4 Vaillant warranty

We only grant a Vaillant manufacturer's warranty if a suitably qualified engineer has installed the system in accordance with Vaillant instructions. The system owner will be granted a warranty in accordance with the Vaillant terms and conditions. All requests for work during the guarantee period must be made to Vaillant Service Solutions (ane 0870 6060 777).

3.5 Recycling and disposal

Both your VRC 430 and its packaging are primarily made of recyclable raw materials.

Appliance

Neither the VRC 430 nor any of its accessories may be disposed of in the household waste. Make sure the old appliance and any accessories are disposed of properly.

Packaging

Please leave the disposal of the transport packaging to the qualified servicing company which installed the appliance.

4 Operation



Note!

Ask your expert technician to explain how to operate the VRC unit after it has been installed. This will prevent accidental changes being made to the settings.

4.1 Overview operating and display front

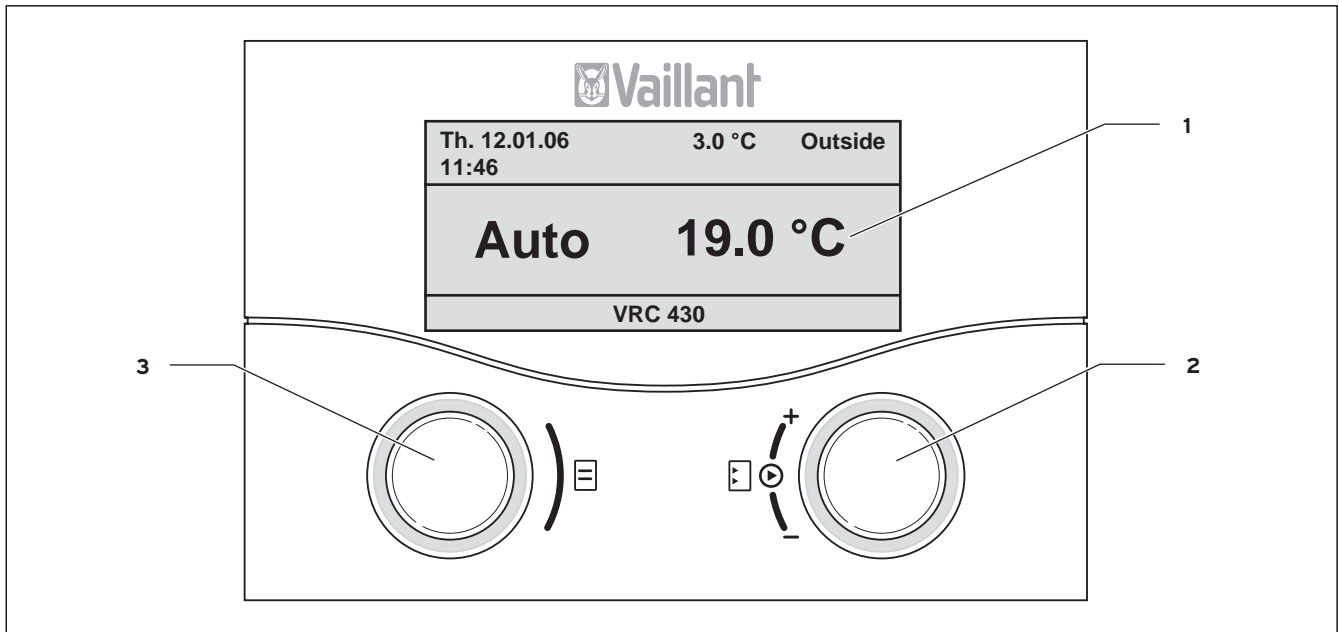

Fig. 4.1 Overview operating and display front

Key

- 1 Display (display field)
- 2 Controls, right-hand dial
- 3 Controls, left-hand dial

Fig. 4.1 shows the default display. The default display shows the following information:

- the operating mode (automatic, manual or off) of the heating circuit 1
- the current internal temperature

The default display is described in detail in Chapter 4.3.3.

The functions of the two dials are described in Chapter 4.3.

4 Operation

4.2 Overview of the display (display field)

The parameters (operating values) of the controller for display and entry are shown on the various display screens.

The display screens are sub-divided into:

- Default display (Fig. 4.1)
- Basic display (Fig. 4.2)
- Display/input screens for certain specific parameters in the operator level (see Chapter 4.4 and 4.5)
- Display/input screens for operating and installation-specific parameters at installer level

All display screens are split into three areas.

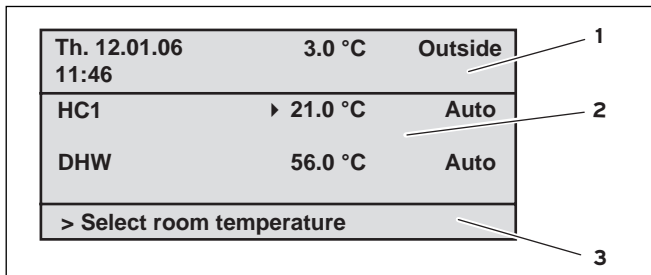

Fig. 4.2 Overview displays (example basic display)

Key

- 1 Area for basic data, title of the screen or status and error messages
- 2 Area for displaying and entering parameters
- 3 Area for displaying explanations

The basic data is:

- Day
- Date
- Time
- External temperature

In the display/input screens for specific parameters, the title of the screen appears instead of the basic data.

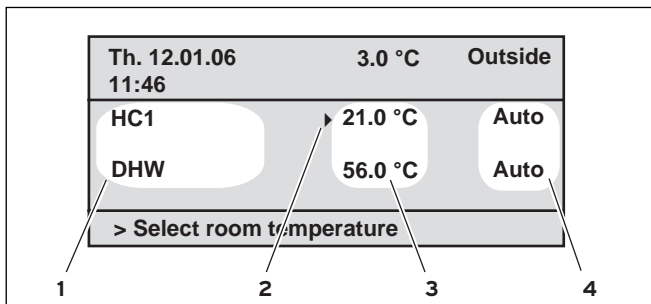

Fig. 4.3 Area for displaying and entering parameters (example basic display)

Key

- 1 Parameter name (display only)
- 2 Cursor ► marks the jump to a modifiable value
- 3 Input field for parameter values; here: set target temperature
- 4 Input field for parameter values; here: Operating mode

4.3 Operating concept

The operating instructions for the simplified basic display are given in Chapter 4.3.3.

The operating concept described below applies to the basic display (Fig 4.2) and the various display/input screens in the operator level.

The two dials (Fig. 4.1 Items 2 and 3) function according to the Vaillant "turn and click" principle.

When the dials are turned (forwards or backwards) you can hear them click into position. When the dial clicks into the adjacent position, the display also moves to the corresponding adjacent position.

Click (press) to select or accept an adjustable parameter.



	Action	Result
Left-hand dial 	Turn	Jump to the next display screen
Right-hand dial 	Turn	Jump to an input field within a screen (marked by the cursor ►)
	Changing a parameter (succession)	
	Click (press)	Activate for the entry (highlighted display)
	Turn	Select the parameter value
	Click (press)	Save selected parameter values

Table 4.1 Operating concept

4.3.1 Show various display screens

You can scroll through the individual screens of the display, like you do with a book, by turning the left-hand dial.

Example:

You are now in the basic display. Instructions for accessing the basic display are given in Chapter 4.3.3

⇒ Turn the left-hand dial one position (click) clockwise.

The screen now shows display page 1 with the options for making changes to the  basic data.

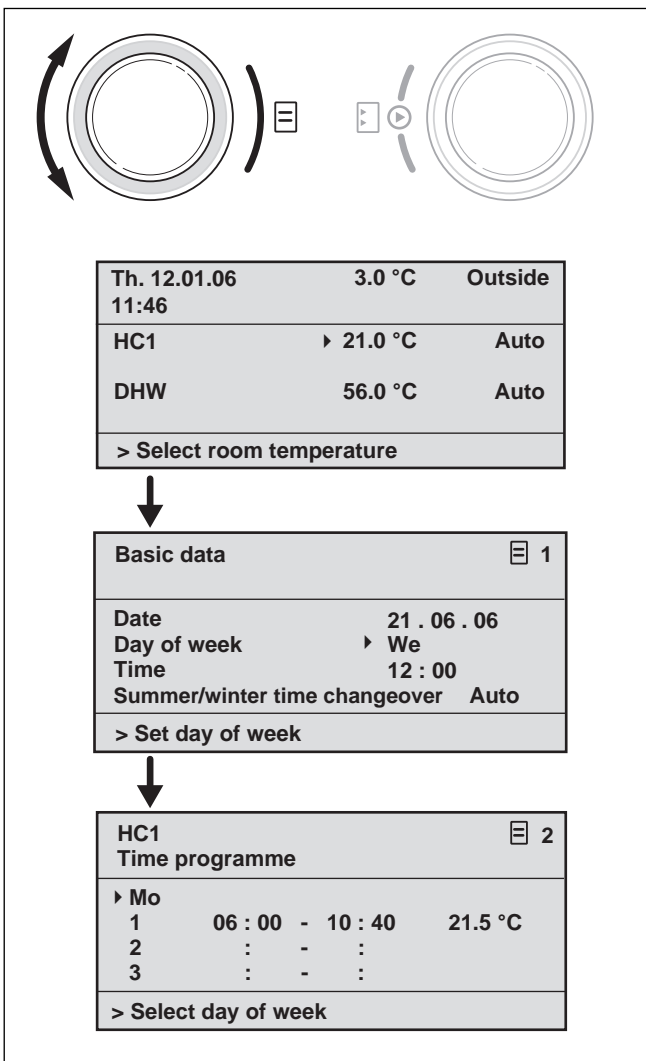

Fig. 4.4 Displaying various screens

4.3.2 Changing parameters

⇒ Rotate the right-hand adjuster to jump to the individual modifiable parameters within the display screen.

The position is indicated by the ▶ cursor (see Fig. 4.5).

If a parameter (e.g. a date with day, month, year) has several elements, jump from one element to the next by rotating the right-hand dial.

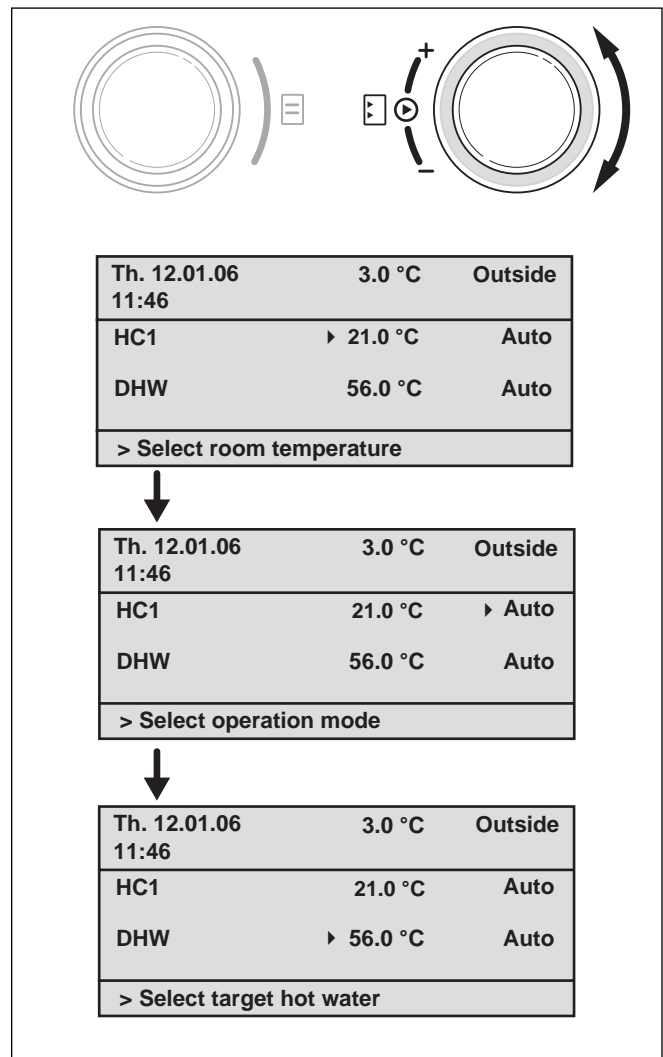

Fig. 4.5 Jump to the various modifiable parameters

4 Operation

⇒ Press the right-hand dial.

The parameter value ▶ marked by the cursor is highlighted.

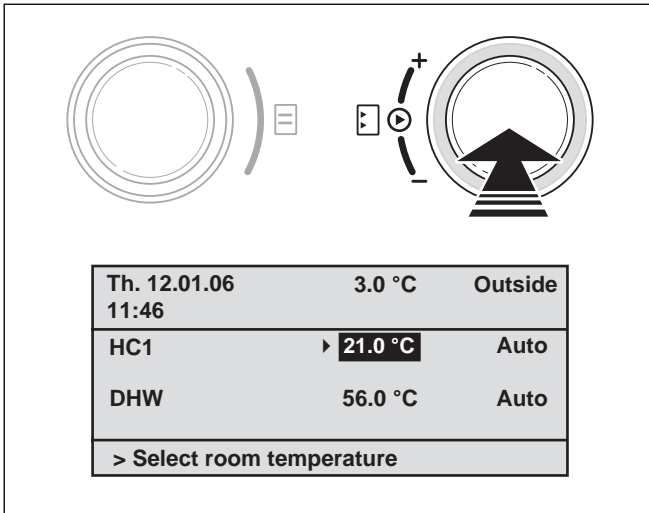

Fig. 4.6 Marking a modifiable parameter

⇒ Rotate the right-hand dial to display in sequence the optional values for this parameter

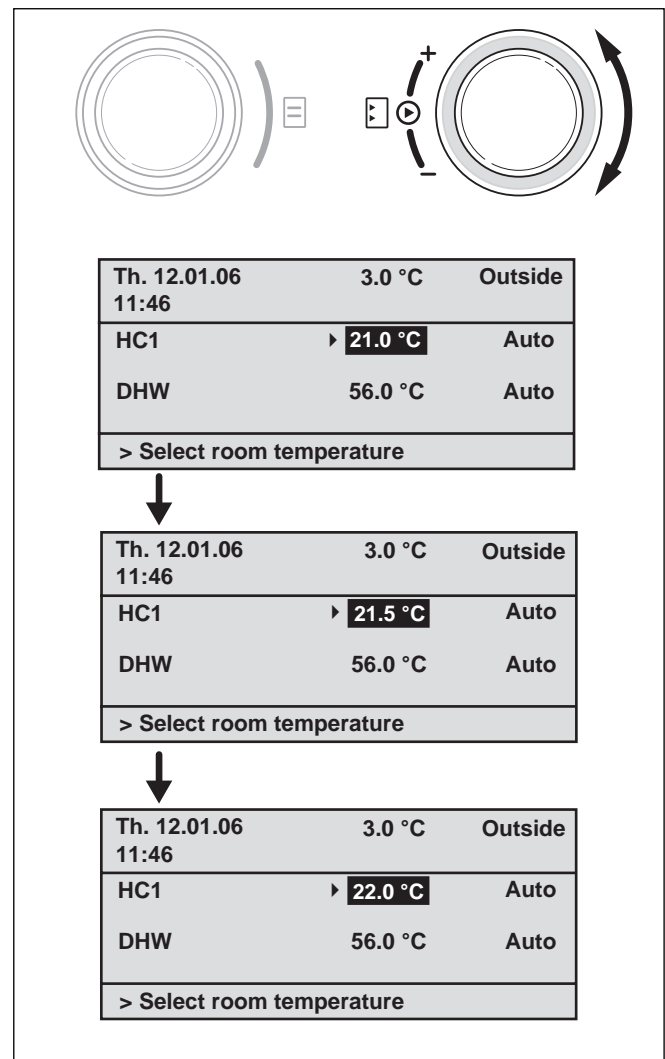

Fig. 4.7 Changing a parameter value

⇒ Press the right-hand dial.

The displayed value is confirmed and accepted for the control system. The value display changes from highlighted to normal.

Changing the parameters in the basic display

	Parameters	Meaning
Heating circuit 1 (HC1)	Room set target temperature	The heating is adjusted according to the modified room target temperature. The length of this control period depends on the operating mode, see also Chapter 4.4.
	Operating mode Auto(matic)	The control system of the heating unit is according to the stipulation of the room target temperature, the time programme and other parameters such as set-back temperature and heating curve. Some of these parameters are set by your expert technician.
	Operating mode Manual	The control system of the heating unit is according to the set room target temperature.
	Operating mode Off	The heating unit is switched off. The target room temperature is not displayed and can therefore not be changed. Frost protection is guaranteed.
Hot water	Hot water target value	Hot water generation is generated according to the new target hot water value. The duration of this control system depends upon the operating mode, see also Chapter 4.4.
	Operating mode Auto(matic)	The hot water is generated according to the target hot water temperature and time settings.
	Operating mode Manual	The hot water control system is based on the hot water target value.
	Operating mode Off	Hot water generation is switched off. The target hot water value is not displayed and is also not modifiable. Frost protection is guaranteed.

Table 4.2 Modifiable parameters in the basic display

Example: Changing the heating circuit target room temperature 1 (HC1)

Initial situation: You are now in the basic screen (see Fig. 4.2). Instructions for accessing the basic display are given in Chapter 4.3.3

- ⇒ Turn the right-hand dial until the cursor ► appears in front of the target value (target room temperature) for heating circuit 1 (HC1).
- ⇒ Press the right-hand dial.

The input field for the set target value is highlighted.

- ⇒ Turn the right-hand dial.

The target room temperature changes by 0.5 °C for every dial position (click).

- ⇒ When you reach the required room target temperature, Press the right-hand dial.

The new value is set. The display jumps highlighted to normal.

The period for which the new control system value remains valid depends on the current operating mode; 4.4

4.3.3 Operation in the default display

Note!
 The simplified basic display always appears if the mixer module VR 61 (for a second heating circuit) is not connected and the VRC 430 is wall-mounted (not on the front of the heating unit).

In the case of the default display (Fig. 4.8) the operating mode for heating circuit 1 and the internal temperature is displayed in the centre section.

The default display also allows you to change the two most important parameters of your heating system quickly and comfortably:

- You can change the operating mode (automatic, manual, off) by rotating the left-hand dial.
- By rotating the right-hand dial you can change between the display of the internal temperature and the input/modification of the target room temperature.

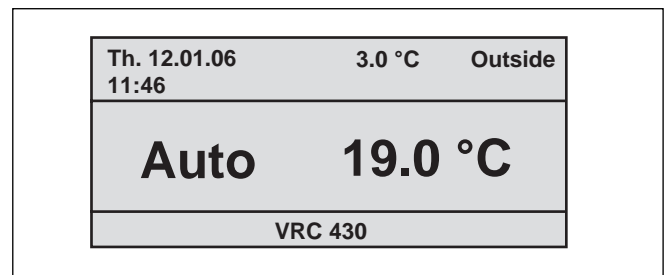

Fig. 4.8 Simplified basic display (example)

Click one or both of the dials to move from the simplified basic display to the next screen (see Fig. 4.2).

If there has been no operation of the controller for a period in excess of 5 minutes, the display jumps back to the simplified basic display.

4 Operation

Changing the operating mode in the simplified basic display

Operating mode	Meaning
Auto(matic)	The heating circuit is controlled according to the target room temperature, the timer programmes, as well as other parameters such as set-back temperature and heating curve. Some of these parameters are set by your expert technician.
Manual	The heating circuit is controlled according to the room target temperature.
Off	The heating circuit is switched off. The target room temperature is not displayed and also cannot be changed. Frost protection is guaranteed.

Table 4.3 Operating modes for the heating unit

Proceed as follows:

⇒ Rotate the left-hand dial.

The operating mode is highlighted. After a delay of 1 second, you can select the operating mode by rotating the left-hand dial. After 2 seconds, the display returns to normal. The selected operating mode is accepted.

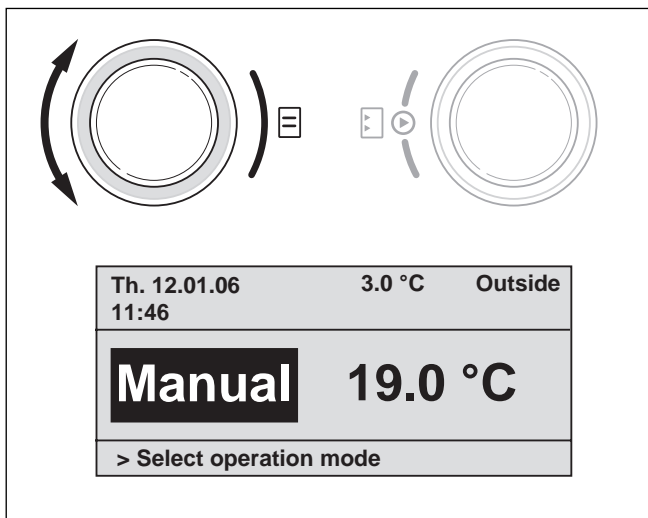

Fig. 4.9 Changing the operating mode in the default display

Changing the target room temperature in the default display

The heating unit is controlled according to the room target temperature. The control system ensures that the target room temperature is achieved quickly and maintained at this value.

For this to happen the selected heating curve must correspond to the conditions and the room temperature control function must be activated.

⇒ Turn the right-hand dial.

The current room target temperature is highlighted rather than the interior temperature. After a delay of 1 second you can select the new target room temperature:

⇒ Rotate the right-hand dial until the desired target room temperature appears.

After a delay of 2 seconds the selected target room temperature is accepted. The display then changes from highlighted to normal and shows the internal temperature.

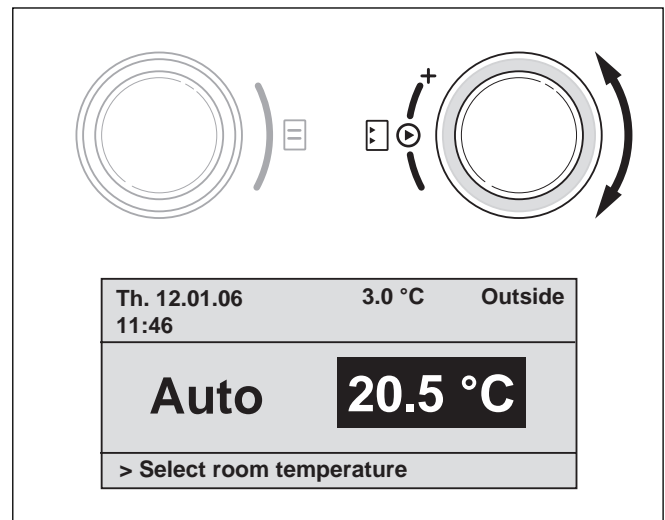

Fig. 4.10 Changing the target room temperature in the basic display

The period for which the new value remains valid depends on the current operating mode; see also Chapter 4.4.

4.4 The period of validity for new control system target values

If you changed a set target value in the basic display – either the room target temperature or the hot water target value – the new value now applies to the entire system.

In the "manual" operating mode the control system operates according to the new value until either the operating mode or the value is changed.

In "automatic" operating mode the control system uses the new value until the next period starts (if you changed the set target value outside a time period) or until the end of the current period (if you changed the set target value within the time window; see Fig. 4.11).

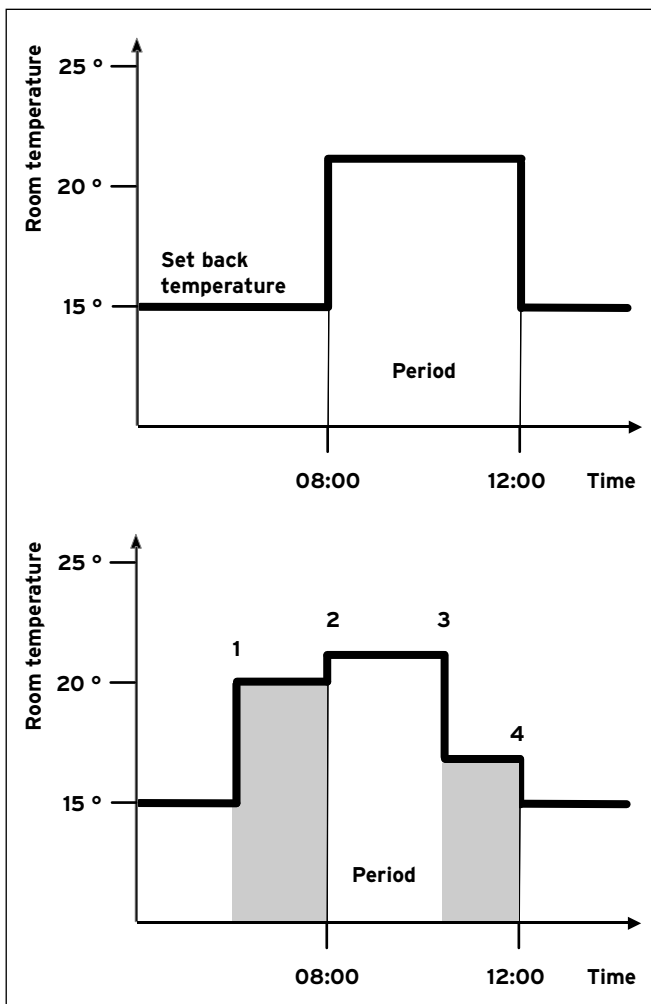

Fig. 4.11 Period of validity of changed set target value (here: Target room temperature)

The top diagram in Fig. 4.11 shows a programmed period (see Chapter 4.7.1) with the associated room set temperature (21 °C).

The lower diagram, the bar marked (1), shows that the target room target value is changed (20 °C). This target value is maintained until the start of the new period. From here (2) the control system uses the room set target value of the time window (21 °C). At (3) the room set target value is set (17 °C). The control system applies this value until the end of this period (4). After this period, the control system reverts to the set-back temperature (15 °C).

Note!
The same applies to the hot water target value.

4.5 Operator level, Expert technician level

The VRC 430 controller has two operating levels. Each level contains several display screens where the parameters can be displayed, set or changed.

- Operating level for the operator
This is used to display, set/change the basic parameters. The parameters can be set/changed by an unskilled operator and during normal operation.
- Operating level for the expert technician
This is used to display and set/change specific parameters and is restricted to the expert technician.

4.6 Screens in the operating level for the operator

The screens in the operation level for operators are arranged the same sequence as shown in table 4.4. below. This table shows the parameters which can be set and changed. Examples of this can be seen in chapter 4.7 below.

To access the first "basic data" screen at operator level from the simplified basic view:

⇒ Click one or both dials.

This will take you to the basic display.

⇒ Turn the left-hand dial clockwise one or two positions (clicks).

Basic data ☰ 1	
Date	21 . 06 . 06
Day of week	▶ We
Time	12 : 00
Summer/winter time changeover	Auto
> Set day of week	

Fig. 4.12 "Basic data" screen (Example: selecting the day of the week)

Turn the left-hand dial again to jump from one screen to the next.

If additional components are installed and controlled by the VRC 430, the display screens listed in table 4.4 will contain the additional screens as required, e.g. ☰ 3 or ☰ 6.

4 Operation

Display screen	Title display screen	adjustable operating values (only display = A)	Remarks	Unit	Min. value	Max. value	Increment/selection option	Preset value
E1	Basic data	Date Day Time	Day, Month and Year selected separately; Hours and minutes selected separately					
		Summer/Winter changeover					Auto, Off	Off
E2	HC1 Time programmes	Day/block	Select single day or block of days (e.g. Mo-Fr)					
		1 Start/end time 2 3	There are three time periods available for each day or block of days	Hours/minutes			10 min	
		Temperature per period	Individual room target temperatures can be set for each period	°C	5	30	0,5	20
E4	Hot water timer programmes	Day/block	Select single day or block of days (e.g. Mo-Fr)					
		1 Start/end time 2 3	Three time periods are available per day or block of days	Hours/minutes			10 min	
E5	Circulation pump time programmes	Day/block	Select single day or block of days (e.g. Mo-Fr)					
		1 Start/end time 2 3	Three time periods are available per day or block of days	Hours/minutes			10 min	
E7	Holiday programme for overall system	Holiday period	Start Day, Month, Year End Day, Month, Year					
		Holiday set target value heating	Target room temperature for holiday period	°C	Frost protection, or 5	30	0,5	Frost protection
E8	HC1 parameters	Set-back temperature	You can specify a set-back temperature for the times between the holiday periods. If your expert technician has set the frost protection function, the set-back temperature is automatically 5 °C. There is no set-back temperature display.	°C	5	30	0,5	15
		Heating curve	The supply temperature of the heating is controlled as a function of the external temperature This relationship is represented in heating curves. You can select from a variety of heating curves (see Chapter 4.7.3).		0,2	4	0,05-0,1	1,2

Table 4.4 Screens in the operating level for the operator

Display screen	Title display screen	adjustable operating values (only display = A)	Remarks	Unit	Min. value	Max. value	Step distance	Preset value
10	Hot water parameters	Hot water target value	Set target temperature for hot water generation	°C	35	70	1,0	60
14	Changing the name	Heating circuit 1	You can enter any name containing up to 8 characters					Heating circuit 1
		Hot water						Hot water
15	Release code level	Code number	Access for the expert technician only by entering saved code number					1000

Table 4.4 Screens in the operating level for the operator (continued)

4.7 Changing the displays (examples)

4.7.1 Entering time programmes (example for heating circuit)

The timer programmes can be used to specify up to three time periods for each day or each block of days (e.g. Mo - Fr). During these time periods the heating control system maintains the set room temperature, the so-called comfort temperature. The temperature is set back outside these time periods.

Note!
 If you carefully adjust the time window according to your lifestyle, you will save energy without losing your heating comfort.

The procedure for setting the time windows is described below heating circuit 1 as an example Time windows can be set in the same way for the hot water preparation and for a circulation pump.

⇒ Turn the left-hand dial until the screen 2, HC1 timer programme, appears 10.

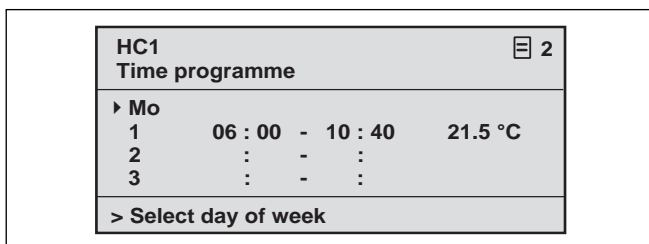

Fig. 4.13 Screen 10 (example)

⇒ Turn the right-hand dial until the cursor ▶ is located in front of the input field for a day or block of days.
 ⇒ Press the right-hand dial.

The input field is highlighted.

⇒ Turn the right-hand dial to select the day or block of days. The following selections are available:
 - Mon, Tue, ... etc.
 - Mon - Fri (Block)
 - Sat - Sun (Block)
 - Mon - Sun (Block)
 ⇒ Confirm your selection by pressing right-hand dial.

1, 2 and 3 on the screen refer to the "time window" that you can set for the selected day or block of days. Within the time window (e.g. from 06:00 am to 10:40 am) the controller regulates the heat as per the comfort temperature (e.g. 21.5 °C).

⇒ Rotate the right-hand dial until the cursor ▶ is located in front of the field for the entering start time for time window 1.
 ⇒ Press the right-hand dial.

The input field is highlighted.

⇒ Select the start time by rotating the right-hand dial.

The time jumps in ten-minute increments for every turn (click) of the dial.

⇒ When the start time is displayed, confirm by clicking the right-hand dial.

4 Operation

The time for the end of the time window 1 should be set accordingly.

The desired comfort temperature for time window 1 is set as follows:

- ⇒ Rotate the right-hand dial until the cursor ▶ is in front of the field for the entering comfort temperature for time window 1.
- ⇒ Press the right-hand dial.

The input field is highlighted.

- ⇒ Turn the right-hand dial to select the desired comfort temperature (the temperature jumps by 0.5 °C for every click).
- ⇒ When the comfort temperature is displayed, confirm by pressing the right-hand dial.

Note!

The controller helps the operator to programme the time windows: You can only enter sequential entries. The timer for a subsequent window cannot be earlier than a previous one.

A time window may only be between 0:00 and 24:00.

An existing time window can be deleted as follows: Set the start time and the end of a window to the same time.

Note!

Set the timer for warm water generation and circulation pump in the same way as for the example, heating circuit 1. There is no need to enter a comfort temperature for hot water generation and circulation pump.

4.7.2 Programming holiday periods

If you will not be home for an extended period, you can set a lower target room temperature for that period. This will save heating energy. The controller ensures that the heater heats up the living rooms to the set temperature only.

You can, for example, specify a target room temperature of 15 °C if you are on holiday from the 10th to the 24th of February. The rooms will only be heated to 15 °C during this period.

You can also select the frost protection function instead of the target room temperature.

Proceed as follows to programme a holiday period:

- ⇒ Turn the left-hand dial until screen  7 "holiday programming for entire system" is displayed.

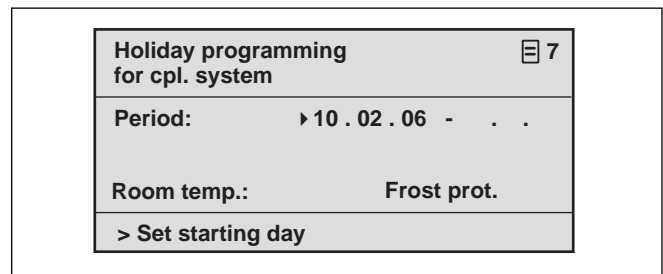

Fig. 4.14 Screen  7 (example)

- ⇒ Turn the right-hand dial until the cursor is ▶ at the beginning of the start date.

The comment field contains the text "Set starting day".

- ⇒ Press the right-hand dial.

The input field is highlighted.

- ⇒ Turn the right-hand dial until the desired starting day is displayed.
- ⇒ Press the right-hand dial.

The start date is set. The display jumps highlighted to normal.

- ⇒ Set the month and year in which the start date occurs in the same way.

The comment field contains the text "Set starting month" or "Set starting year".

- ⇒ Set the end date for the holiday period in the same way.

Enter the target room temperature as follows:

- ⇒ Turn the right-hand dial until the cursor ▶ is in front of the input field for the target room temperature.

The comment field contains the text "Select target room temperature".

⇒ Press the right-hand dial.

The input field is highlighted.

⇒ Turn the right-hand dial until the desired value is displayed (values from 5 °C to 30 °C in increments of 0.5 °C and frost protection function are possible).

⇒ Press the right-hand dial.

The desired target room temperature or the frost function are set. The display jumps highlighted to normal.

4.7.3 Entering parameters for the heating circuit

You can enter the following parameters:

Set-back temperature

Outside the specified time windows, the heating is reduced to the set-back temperature.

If your expert technician has set the frost protection function, the set-back temperature will automatically be 5 °C. There is no display of set-back temperature.

Heating curve

The relationship between the outside temperature and the required heating feed temperature is represented in a diagram having various different heating curves (see Fig. 4.15). Each heating curve (from 0.2 - 4.0) gives a value for the heating flow temperature (vertical diagram axis) for the individual outside temperature (horizontal diagram axis).

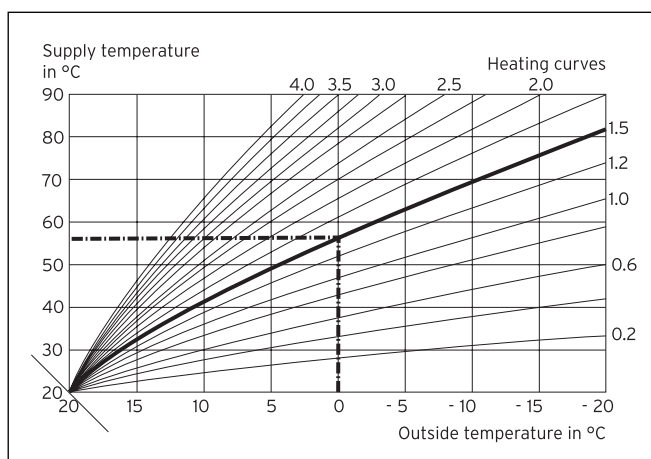

Fig. 4.15 Diagram with heating curves for a target room temperature of 20 °C

Example:

If you select a heating curve of 1.5 with a target room temperature of 20 °C, the controller provides a heating flow temperature of 56 °C at an outside temperature of 0 °C.

The various heating curves indicate whether the heating flow temperature should be higher or lower depending on the outside temperature.



Note!

In a well-insulated apartment a comfortable room temperature can be achieved even with a flat heating curve. This saves heating energy. Your expert heating technician will provide advice as to which heating curve should be selected.

Proceed as follows to enter the parameters (example heating circuit 1):

⇒ Turn the left-hand dial until screen  "HC1 parameters" is displayed.

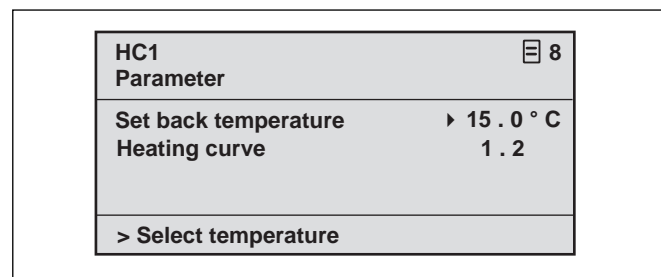

Fig. 4.16 Display screen  (example)

⇒ Turn the right-hand dial until the cursor ▶ is in front of the input field for the set-back temperature.

The comment field contains the text "Set temperature".

⇒ Press the right-hand dial.

The input field is highlighted.

⇒ Turn the right-hand dial until the desired value is displayed (values from 5 °C to 30 °C in increments of 0.5 °C are possible).

⇒ Press the right-hand dial.

The desired set-back temperature is set. The display jumps highlighted to normal.

⇒ Turn the right-hand dial until the cursor ▶ is in front of the heating curve value.

The display field shows the text "set heating curve" in the comment field.

⇒ Press the right-hand dial.

4 Operation

The input field is highlighted.

- ⇒ Turn the right-hand dial until the desired value is displayed (values from 0.2 to 4.0 are possible, see Fig. 4.15).
- ⇒ Press the right-hand dial.

The desired heating curve is set. The display changes from highlighted to normal.

4.7.4 Entering parameters for hot water generation

If the heating unit also heats your hot water, you can enter the set target temperature on the controller.

- ⇒ Turn the left-hand dial until screen  10 "Hot water parameters" is displayed.

The cursor  is located in front of the value for the set target temperature.

- ⇒ Press the right-hand dial.

The input field is highlighted.

- ⇒ Turn the right-hand dial until the desired value is displayed (values from 35 °C to 70 °C in increments of 1 °C are possible).
- ⇒ Press the right-hand dial.

The desired set target temperature is set. The display jumps highlighted to normal.



Caution!

Risk of being scalded by hot water!
At the draw-off locations for the hot water there is a danger of scalding at temperatures in excess of 60 °C. Young children and elderly persons can be in danger even at lower temperatures.
Select the target temperature so that nobody is in danger.

4.7.5 Renaming the heating components

Screen  14 indicates which components you can re-name.

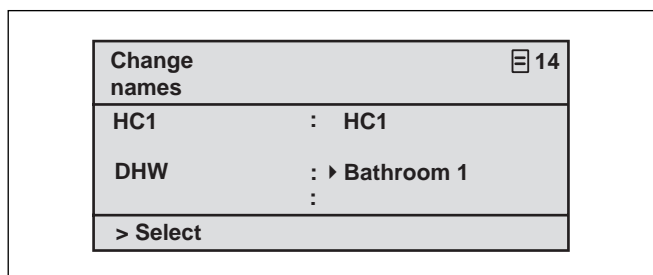



Fig. 4.17 Screen  14 (example)

You can enter a new name to the right of the colon (numbers 0-9, spaces, capital/small letters). Proceed as follows:

- ⇒ Turn the left-hand dial until screen  14 "Change names" is displayed.
- ⇒ Turn the right-hand dial until the cursor  is in front of the name you wish to change.
- ⇒ Press the right-hand dial.

The character is highlighted.

- ⇒ Turn the right-hand dial until the desired letter or number is displayed.
- ⇒ Press the right-hand dial.

The character is accepted. The character switches from highlighted to normal.

- ⇒ Turn the left-hand dial clockwise by one click.

The next character is marked by the cursor.

- ⇒ Press the right-hand dial.

The character is highlighted.

- ⇒ Turn the right-hand dial until the desired letter or number is displayed.
- ⇒ Proceed in the same way for the rest of the characters in the name.



Note!

You can delete entire names or extra characters by entering spaces.

5 Status and error messages

Status and error messages are displayed in the second row of the basic data section.

Status messages

- Holiday programme active

Within a specified holiday period the heating is controlled according to the temperatures set for that period.

- Maintenance + telephone number of the expert technician

*Indicates that the heating system requires maintenance work.
The telephone number of your expert technician will also appear if it has been entered into the system.*

Error message:

Fault on heating unit.

Draws attention to a fault in the heating unit.

⇒ Contact your expert technician.

The unit is faulty if the screen remains dark or you are unable to make any changes using the dial.

⇒ Contact your expert technician.

For the heating engineer:

Installation Manual

VRC 430

Weather compensator

VRC 430

Contents

1	Notes on the documentation.....	2	5	Installation.....	7
1.1	Storing of the documents.....	2	5.1	Electrical installation of the controller when mounted on the wall.....	7
1.2	Symbols used.....	2	5.2	Electrical installation of the external sensor VRC 693.....	8
1.3	Applicability of the manual.....	2	5.3	Electrical installation of the external sensor VRC 9535.....	8
2	Description of the appliance	3	6	Initial start-up.....	9
2.1	Identification plate.....	3	6.1	Installation assistant	9
2.2	CE label.....	3	6.2	Expert technician level	9
2.3	Intended use.....	4	6.3	Restoring default parameters	10
3	Safety instructions and regulations	4	6.4	Grout drying function	13
3.1	Safety information.....	4	6.5	Handing over the appliance to the owner	13
3.2	Regulations.....	4	7	Service, warranty	13
4	Assembly	5	7.1	Vaillant service	13
4.1	Scope of delivery	5	7.2	Vaillant warranty.....	13
4.2	Accessories.....	5	8	Recycling and disposal.....	14
4.3	Location.....	5	9	Technical data.....	14
4.4	Fitting the controller in the heating unit	5	Glossary	15	
4.5	Wall mounting the controller	6			
4.6	Fitting the external sensor	6			

1 Notes on the documentation

1 Notes on the documentation

The following information is intended to help you work through the documentation. Additional documents apply in conjunction with this installation manual.

We accept no liability for any damage caused by failure to observe these instructions.

Other applicable documents

- The operating instructions for the Vaillant controller VRC 430 (Section 1 of this document)
- The operating and installation instructions for your heating unit
- All instructions for accessory components

1.1 Storing of the documents

Please pass on this installation manual and all other valid documents and auxiliary equipment to the owner of the unit. This person is responsible keeping these documents safe. The documents must be made available if required.

1.2 Symbols used

Please observe the safety instructions in this manual when installing the unit!



Danger!
Danger of death by electrocution!



Danger!
Immediate risk of serious injury or death!



Caution!
Danger of burning and scalding!



Caution!
Potentially dangerous situation for the product and environment!



Note!
Useful information and instructions.

⇒ Symbol indicating a required task

1.3 Applicability of the manual

These installation instructions apply exclusively to appliances with the following article numbers:

0020028520 VRC 430

The part number of your unit can be obtained from the identification plate.

2 Description of the appliance

The VRC 430 is a weather compensator designed for heating and hot water generation in conjunction with a Vaillant boiler (eBUS-capable).

The VRC 430 can also be used to control the following accessory components:

- Circulation pump for hot water generation in conjunction with a multi-functional module 2 of 7
- Conventional domestic hot water cylinder
- Vaillant layer hot water storage tank actoSTOR
- Second heating circuit using the Vaillant Mixer Module VR 61
- Solar unit using the Vaillant Solar Module VR 68

On the VRC 430 data is exchanged and power supplied via an eBUS interface.

The VRC 430 can be operated with the Vaillant remote control VR 81.

The VRT 430 is equipped for operation with the Vaillant diagnosis software vrDIALOG 810/2 and with the Vaillant Internet Communication System vrnetDIALOG, i.e. for remote diagnosis and remote setting.

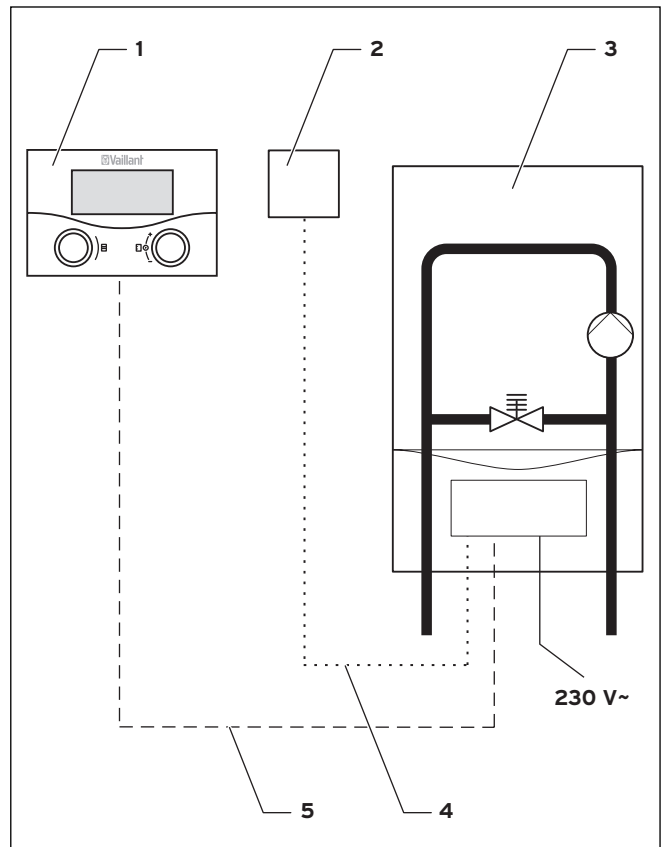

Fig. 2.1 System diagram

Key

- 1 VRC 430
- 2 External sensor VRC 693 or VRC 9535 (DCF)
- 3 Boiler
- 4 Cable connection (VRC 693: twin core; VRC 9535: 3 core)
- 5 eBUS connection (twin core)

2.1 Identification plate

The identification plate is located on the rear of the controller electronics (printed circuit board).

2.2 CE label

The CE label indicates that the Vaillant controller VRC 430 complies with the basic requirements of the following guidelines:

- Electromagnetic compatibility directive (Guideline 89/336/EEC)
- Low voltage directive (Guideline 73/23/EEC)

2 Description of the appliance

3 Safety instructions and regulations

2.3 Intended use

The VRC 430 weather compensator is a state-of-the-art appliance constructed in accordance with recognised safety regulations.

However, damage and property may occur if the unit is used improperly or for a purpose other than the intended purpose.

The VRC 430 controller is designed for use as a weather compensator and timer-based controller with or without hot water generation/ circulation pump in conjunction with a Vaillant heating unit with eBUS interface.

Operation with the following accessories is permitted:

- Circulation pump for hot water generation in conjunction with a multi-functional module 2 of 7
- Conventional domestic hot water cylinder
- Vaillant layer hot water storage tank actoSTOR
- Second heating circuit using the Vaillant Mixer Module VR 61
- Solar unit using the Vaillant Solar Module VR 68
- VR 81 remote control device

Any other or extended use is considered to be use other than intended. The manufacturer or supplier is not liable for any resulting damage. The owner alone bears any risk.

Intended use also includes observing the operating and installation instructions and all other applicable documents.

3 Safety instructions and regulations

The controller must be installed by a suitably qualified expert technician, who is responsible for observing existing standards and regulations. We accept no liability for any damage caused by failure to observe these instructions.

3.1 Safety information



Danger!

Live connections!

There is a danger to life from electrocution when working on the electronics box of the boiler.

Switch off the power supply to the electronics box of the heating unit and secure against re-connection before carrying out any work.

Only open the electronics box if the heating unit is disconnected from the power source.

3.2 Regulations

During the electrical installation, observe the VDE and EVU regulations.

Use standard commercial cables for wiring.

Minimum cross-section for sensor and Bus lines:
0.75 mm²

Do not exceed the following maximum wire lengths:

- Sensor lines 50 m
- eBUS lines 300 m

If sensor and eBUS lines run parallel with 230 V cables for more than 10 m, they must be laid separately.

Do not use free terminals of the appliances as support terminals for other wiring.

The controller may only be installed in dry rooms.

All wiring must be in accordance with Building Regulations Part P and BS 7671 (IEE Wiring Regulations), and must be carried out by a suitably qualified person.

4 Assembly

The VRC 430 can either be integrated in the heating unit or mounted separately in the living area on a wall. When mounting on the wall, the connection to the heating unit is via a twin-core eBUS line.

The VRC 430 is supplied with one of the following external sensors:

- VRC 693
connection is via a twin core cable to the heating unit
- VRC 9535 (DCF)
connection is via a 3-core cable to the heating unit

4.1 Scope of delivery

Using Table 4.1, check the scope of delivery

Pos.	Number	Component
1	1	Controller VRC 430
2	1	External sensor VRC 693 or External sensor VRC 9535 (DCF)
3	1	Fixing material
4	1	6-pole edge connector
5	1	Operating and Installation Manual

Table 4.1 Scope of supply VRC 430

4.2 Accessories

The following accessories can be used to extend controller functionalities:

2 of 7 multi-functional modules

The multi-function module VR 2 of 7 can be used by the VRC 430 to control a circulation pump.

VR 61 mixer module

The mixer-module VR 61 extends the VRC 430 functionality to include a twin-circuit controller.

Solar module VR 68

The solar module VR 68 can be used by the VRC 430 to control a solar installation.

VR 81 remote control unit

The remote control VR 81 is recommended if the VRC 430 is fitted in the heating unit, or if the second heating circuit is to be controlled decentrally. The remote control VR 81 can be used to set the following parameters:

- Operating mode
- Target room temperature

Symbols are displayed indicating maintenance and error messages.

Data interchange is via eBus line.



Note!

If accessory components are connected to the VRC 430, the instructions for these components must also be observed.

4.3 Location

The controller should only be installed in dry rooms.

If the controller is mounted on the wall, it should be fitted in such a way that the room temperature is measured properly; e.g. on an internal wall of the main living room, at a height of approx. 1.5 m

If the thermostat function is activated, advise the operator that all the radiator valves must be fully open in the room where the controller is mounted.

See Chapter 4.6 for information on locating the outdoor sensor.

4.4 Fitting the controller in the heating unit



Danger!

Live connections!

There is a danger to life from electrocution when working on the electronics box of the boiler.

Switch off the power supply to the electronics box of the heating unit and secure against re-connection before carrying out any work.

Only open the electronics box if the heating unit is disconnected from the power source.

Proceed as follows:

- ⇒ Switch the boiler off.
- ⇒ Turn off the power supply to the heating unit and secure the power supply against re-connection.
- ⇒ Remove the front screen from the heating unit.
- ⇒ Carefully press the controller (without wall plinth, see Fig. 4.1) with the pin rail into the plug connector on the heating unit.
- ⇒ Now fit the external sensor (see Chapter 4.6), if not already done.
- ⇒ Carry out the electrical installation of the external sensor as described in Chapter 5.2 or 5.3.
- ⇒ Re-connect the power supply to the heating unit.
- ⇒ Switch the heating unit on again.

4 Assembly

4.5 Wall mounting the controller

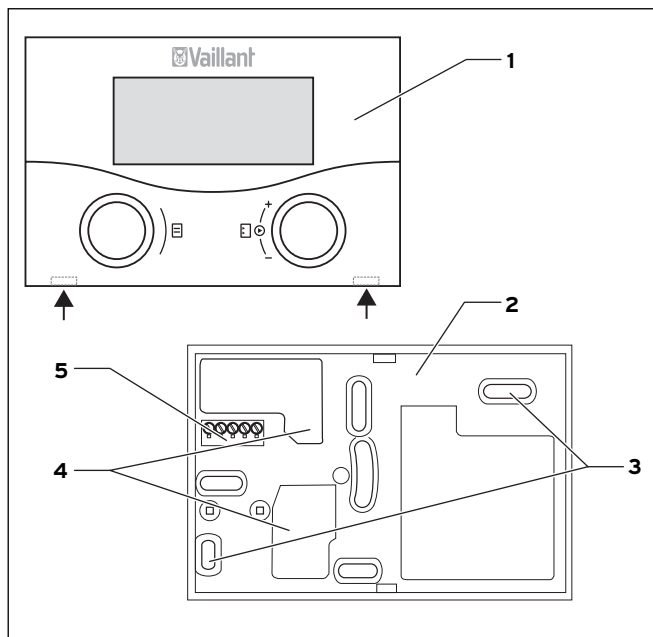

Fig. 4.1 Fitting the external sensor 430

Key

- 1 Controller VRC 430
- 2 Wall plinth
- 3 Installation opening
- 4 Openings for cable duct
- 5 Terminals for eBUS line and plug connection for pin rail

Proceed as follows:

- ⇒ Pull the room thermostat (1) off the wall plinth (2).
This can be done by pushing a screwdriver into the two retaining straps (see Fig. 4.1 arrows).
- ⇒ Mark the position on the wall. Take the eBUS line route into account when doing so.
- ⇒ Drill two holes 6 mm in diameter to match the fixing apertures (3).
- ⇒ Insert the rawl plugs supplied.
- ⇒ Insert the eBUS cable through one of the cable conduits (4).
- ⇒ Use the screws supplied to fix the wall socket.
- ⇒ Electrical installation is described in Chapter 5.1.
- ⇒ Carefully press the controller onto the wall socket until it clicks into position. The pin rail on the back of the controller must fit into the plug connector (5) on the wall socket.

4.6 Fitting the external sensor

The mounting location of the external sensor should meet the following conditions:

- not fully protected from wind
- no particularly draughty
- no direct sunlight
- no influence from heat sources
- N or NW facing facade

On buildings with up to 3 floors, the external sensor should be two-thirds up the building; on buildings with more than 3 floors, install it between the 2nd and 3rd floors.



Caution!

Dampness in the wall and in the unit!
Incorrect installation can result in damage to the unit and/or the wall of the building.
Observe the cable routing described and the correct installation position of the external sensor.



Note!

Installation is the same for both external sensors, with the following exceptions:

- the VRC 693 requires a two-core connection cable
- the VRC 9535 requires a three-core connection cable

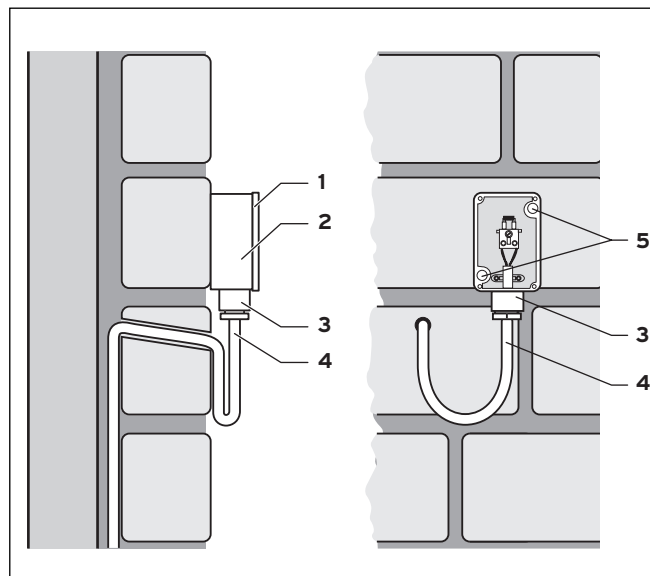

Fig. 4.2 Fitting the external sensor VRC 693

Key

- 1 Casing cover
- 2 Wall plinth
- 3 Cap nut for cable conduit
- 4 Connection cable with drip loop
- 5 Installation opening

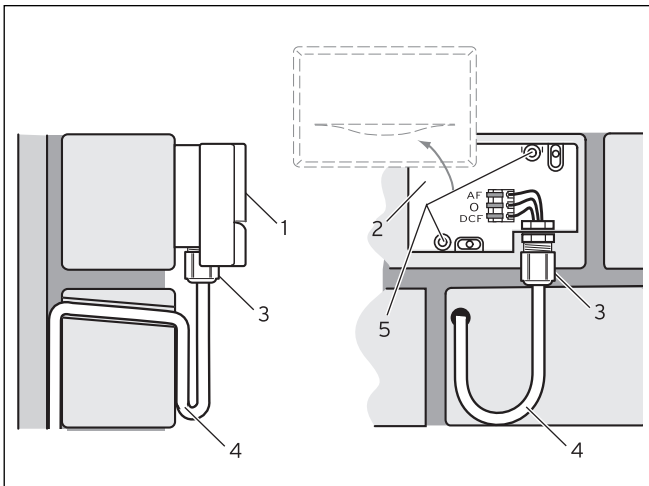

Fig. 4.3 Fitting the external sensor VRC 9535

Key

- 1 Casing cover
- 2 Wall plinth
- 3 Cap nut for cable conduit
- 4 Connection cable with drip loop
- 5 Installation opening

Proceed as follows:

- ⇒ Mark the position on the wall. Observe the cable routing for the external sensor.
- ⇒ Route the connection cable (4) with a slight incline to the outside and with a drip loop.
- ⇒ Remove the cover (1) from the external sensor casing.
- ⇒ Drill two holes 6 mm in diameter to match the fixing apertures (5).
- ⇒ Insert the rawl plugs supplied.
- ⇒ Fix the wall socket (2) to the wall with 2 screws. The cable entry must point downwards.
- ⇒ Release the cap nut (3) slightly and push the connection cable through the cable entry from below.
- ⇒ The electrical installation is described in Chapter 5.2 for the VRC 693, and in Chapter 5.3 for the VRC 9535.
- ⇒ Re-tighten the cap nut (3). The packing in the cable entry adapts to the diameter of the cable used (Cable diameter: 4.5 to 10 mm).
- ⇒ Carefully push the cover for the enclosure onto the wall socket until it clicks in position. Do not forget the seal between the wall socket and the cover for the enclosure.

5 Installation

Danger!
Live connections!

There is a danger to life from electrocution when working on the electronics box of the boiler.

Switch off the power supply to the electronics box of the heating unit and secure against re-connection before carrying out any work. Only open the electronics box if the heating unit is disconnected from the power source.

If the controller is installed in the heating unit, the electrical connection is made by the contact between the pin rail of the controller and the corresponding plug connection in the heating unit.

5.1 Electrical installation of the controller when mounted on the wall

The power supply to the heating unit is switched off and secured against re-connection.

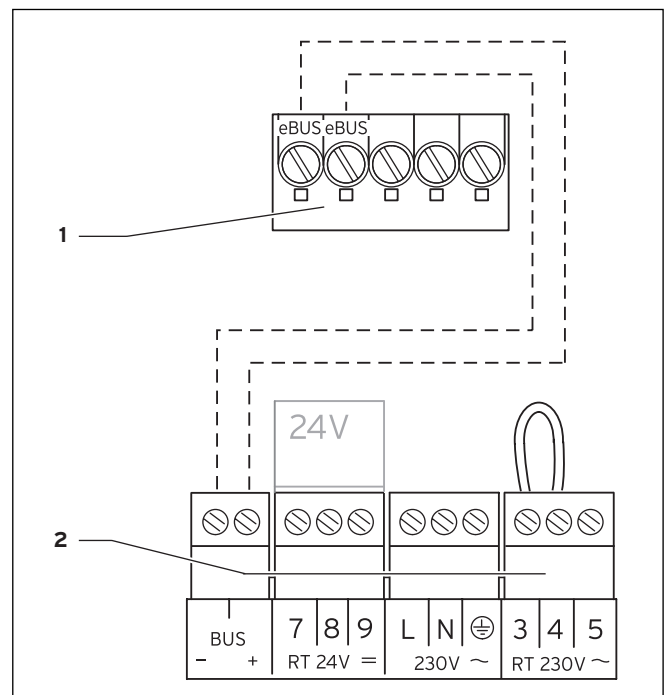

Fig. 5.1 Electrical connection with VRC 430

Key

- 1 Terminal rail VRC 430
- 2 Heating unit terminal rail

5 Installation



Note!

The bridge between the terminals 3 and 4 (see Fig. 5.1) should not be removed. When connecting the eBUS cable there is no need to make sure the polarity is correct. Communication is not adversely impacted if the two connections are swapped over.

Proceed as follows:

- ⇒ Connect the eBUS cable to the VRC 430 terminal rail.
- ⇒ Connect the eBUS cable to the terminal rail on the heating unit.

5.2 Electrical installation of the external sensor VRC 693

The power supply to the heating unit is switched off and secured against re-connection.

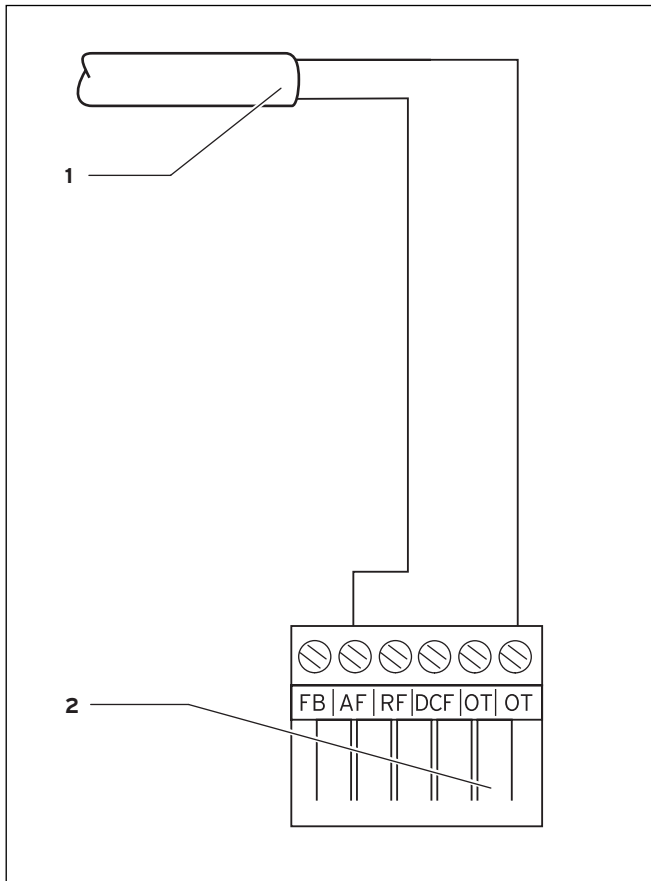

Fig. 5.2 Electrical connection of VRC 693

Key

- 1 Connection cable to the external sensor VRC 693
- 2 6-pole edge connector for plug location X41 (heating unit)

Proceed as follows:

- ⇒ Connect the connection cable to the terminals on the external sensor as per Fig. 4.2.
- ⇒ Connect the connection cable to the 6-pole edge connector as per Fig. 5.2.
- ⇒ Connect the 6-pole edge connector to plug location X41 on the heating unit.

5.3 Electrical installation of the external sensor VRC 9535

The power supply to the heating unit is switched off and secured against re-connection.

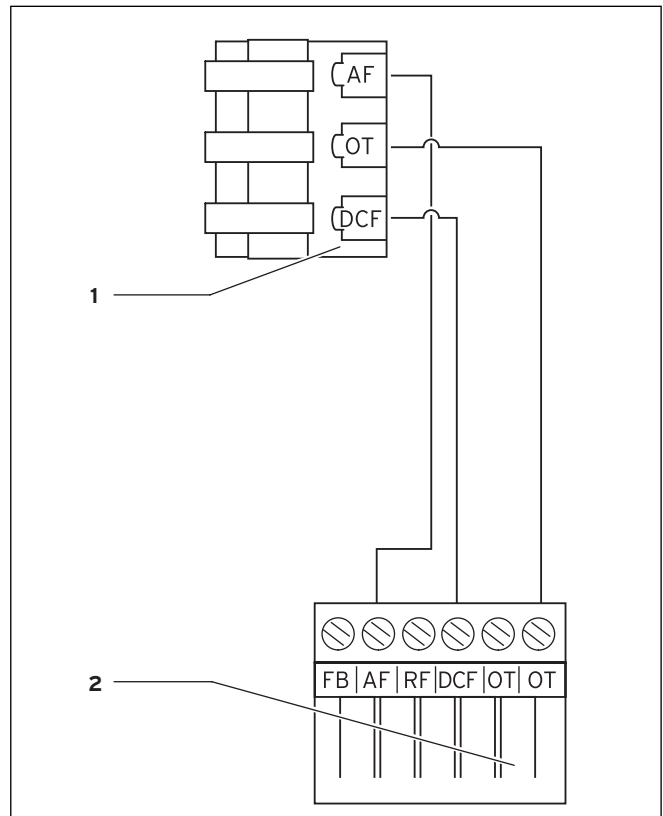

Fig. 5.3 Electrical connection of the external sensor VRC 9535

Key

- 1 Terminal rail VRC 9535 external sensor
- 2 6-pole edge connector for plug location X41 (heating unit)

Proceed as follows:

- ⇒ Connect the connection cable to the terminal rail of the external sensor as per Fig. 5.3.
- ⇒ Connect the connection cable to the 6-pole edge connector as per Fig. 5.3.
- ⇒ Connect the 6-pole edge connector to plug location X41 on the heating unit.

6 Initial start-up

Initial situation:

The controller and the external sensor are correctly installed and connected.
The heating unit is switched on and ready for operation.

Note!

Ensure that both rotary knobs (outlet-/hot water cylinder temperature and heating flow temperature) on the boiler are at the maximum position (all the way to the right). This ensures optimum control system by the VRT 430.

The VRC 430 operating concept is described in the operating instructions in Chapter 4.3.

6.1 Installation assistant

The installation assistant will help you with the initial start-up. The installation assistant recognises the components connected to the heating system.

Depending on the configuration of the heating unit, up to six screens (A1 to A6) are available. You can enter the most important parameters of the heating system using the installation assistant.

The installation assistant starts with screen A1, language selection.

⇒ Select the language as per the operating concept (operating instructions 4.3).

⇒ Turn the left-hand dial clockwise by one click to access screen A2.

Installation assistant	A 2
System configuration	
Mixer mode HC1	DC
Cylinder	▶ active
> Select	

Fig. 6.1 Installation assistant screen A2

The heating system configuration is shown on screen A2.

In the heating circuit mode HC1 you can select between burner circuit (BK) and inactive.

In Cylinder you can choose between active and inactive.

⇒ Turn the left-hand dial clockwise by one click to access screen A5.

You can check the heating generator settings on screen A5:

- ⇒ Select 50 °C as the parameter value for the "Activation heater" parameter.
- ⇒ Check the boiler reaction.

If you want to make any other changes:

- ⇒ Turn the left-hand dial anticlockwise to return to any of the previous screens.

To exit the installation assistant:

- ⇒ Turn the left-hand dial clockwise to access screen A6.
- ⇒ Click "Yes" to exit.

Note!

If you confirmed the end of the installation with "yes" you can only access the installation assistant via the code-protected Expert Technician Level.

6.2 Expert technician level

The expert technician level is used to display and set/change specific operating data. This allows the control system to be set according to the heating system. This is advisable if the heating installation has other components in addition to the heating circuit 1 (HC 1)(e.g. heating circuit 2, domestic hot water cylinder, solar energy system).

Note!

Please refer to the individual operating manuals for component controller function descriptions.

The expert technician level includes screens C1 to C26 and the screens A1 to A6 of installation assistant as described above.

Screens C1 to C26 in the VRT 430 appear in the same sequence as shown in table 6.1 below.

This table shows the parameters which can be set and changed.

Depending upon the configuration selected, non-required parameters are not displayed on the installation assistant (screen A2).

The settings/changes take place in accordance with the operating concept as described in Chapter 4.3 of the operating instructions .

In order to get to the expert technician level, you need to enter an access code.

From the simplified basic display you can access the expert technician level as follows:

6 Initial start-up

- ⇒ Click with one or both of the dials to access the basic display from the simplified basic display.
- ⇒ Turn the left-hand dial clockwise until screen 15 is displayed.
- ⇒ Enter the code.

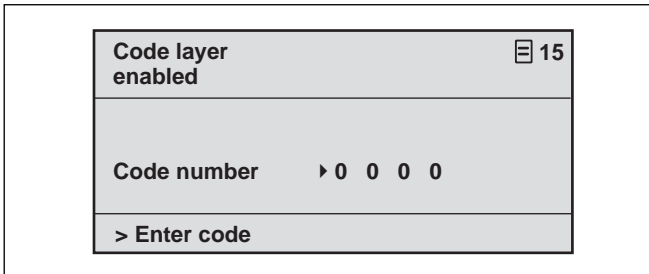

Fig. 6.2 Screen 15

The default code is 1000.

You can change the code on screen C24.

After entering the correct code you automatically access screen C1 on the expert technician level.

6.3 Restoring default parameters

You can restore the VRC 430 default settings as follows:

- ⇒ Simultaneously press and hold both dials for 10 seconds

You will access the screen for the default settings

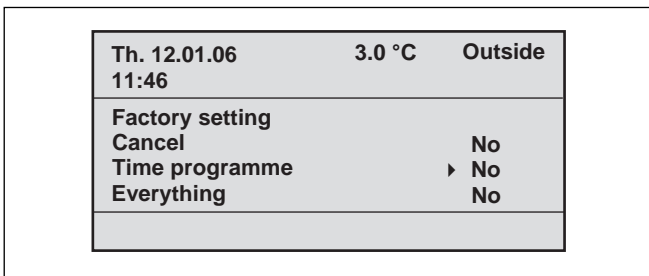

Fig. 6.3 Default settings screen

Menu point	Input	Result
Cancel	Yes	The set parameters remain effective
Time programmes	Yes	All programmed time windows are deleted
Everything	Yes	The default settings for all parameters are restored

Table 6.1 Menu selection, default settings screen

After confirming the input, the display returns to the basic display or to the simplified basic display.

Display screen	Title display screen	adjustable operating values (only display = A)	Remarks	Unit	Min. value	Max. value	Step width	Preset value
C1	HC1 Information	Supply target (A)	Flow temperature target value	°C			1	
		Pump status (A)					On, Off	
		FBG connection/ room actual value	Remote control connected? Room actual display	°C			Yes, no and 0.5	
C3	Hot water generator information	Installation sensor VF1 (A)	Actual value at the feed sensor 1 or the internal sensor of the heat generator	°C			1	
		Flame status boiler (A)					Off, heating mode, hot water mode	
C4	Hot water information	current hot water set target value (A)	Hot water set target temperature of the storage tank	°C			1	
		Storage probe 1 (A)	Actual cylinder hot water temperature	°C			1	
		Circulation pump status (A)					On, Off	
C8	HC1 parameters	Heating circuit type (A)	Status display				Heating circuit, inactive	
		Switch-on room temperature	selectable with wall mounting of the controller or remote control				none, modulating, thermostat	none
		Summer operation mode Offset	If the outside temperature > target room temperature + Summer Offset, the boiler switches off	R	0	30	1	1
C9	HC1 parameters	Set-back temperature	You can specify a set-back temperature for the times between the holiday periods. If your expert technician has set the frost protection function, the set-back temperature is automatically 5 °C. There will be no display as set-back temperature	°C	5	30	1	15
		Heating curve	in accordance with the diagram operating instructions Chapter 4.7.3		0,2	4	0,05-0,1	1,2
		Minimum temperature	Minimum feed temperature	°C	15	90	1	15
C16	Hot water parameters	Legionella protection day	Day or block of days; The cylinder is heated to 70 °C for an hour				OFF, MO, TU, WE, TH, FR, SA, SU, MO-SU	OFF
		Legionella protection start time			0:00	24:00	0:10	4:00

Table 6.2 Display screens in expert technician level

6 Initial start-up

Display screen	Title display screen	adjustable operating values (only display = A)	Remarks	Unit	Min. value	Max. value	Step width	Preset value
C21	Total system parameters	Mode Auto_OFF	Determines the heating control system outside the programmed time window				Frost protection, ECO, set-back	ECO
		Frost protection delay time	Delay time of the start of the frost protection function or the ECO function.	Hrs.	0	12	1	4
		Max. pump blocking time	If the supply target temperature is achieved for a longer period of time, the heating is switched off for the prescribed pump-blocking time (depends on the external temperature)	Mins.	Off, 5	60	1	15
C22	Total system parameters	Max. pre-heating time	Before the start of the first time window	Mins.	0	300	10	0
		Max. pre-switch off time	Before the end of a time window	Min.	0	120	10	0
		AT through-heating	External temperature from which continuous through-heating takes place	°C	OFF, -25	+10	1	Off
C23	Floor drying function	Floor drying function - day	See Section 6.4 Floor drying function	Day	0	29	1	0
		Floor drying function /pre-heat actual (A)	See Section 6.4 Floor drying function	°C				in accordance with temperature profile
C24	Service	Telephone number FHW	Enter telephone number to be used in the event of service					
		Changing the code number			0000	9999	each 1	1000
		Maintenance date	Day/Month/Year adjustable					
C25	Tools	Outside temperature correction	Matching of the external sensor	R	-5	5	1,0	0
		Correction room actual value	Matching the room temperature sensor	R	-3	3	0,5	0
		Display contrast			0	15	1	6
C26	Software versions	Software version per module (A)	Version number display					

Table 6.2 Screen in expert technician level (continued)

6.4 Grout drying function

The floor-drying function is used to "heat dry" a freshly laid heating layer according to building regulations.

If this function is activated, all selected operating modes are stopped.

The flow temperature of the controlled heating circuit is controlled according to a pre-set program regardless of the outside temperature.

Starting temperature: 25 °C

Days after starting the function	Target flow temperature for this day [°C]
1	25
2	30
3	35
4	40
5	45
6-12	45
13	40
14	35
15	30
16	25
17-23	10 (frost protection function, pump in operation)
24	30
25	35
26	40
27	45
28	35
29	25

Table 6.3 Temperature profile, floor drying

In the expert technician level, screen C23, the controller VRC 430 shows the operating mode for floor drying along with the current day and the associated supply target temperature.

The current day can be set manually.

When the function is started, the current time of the start is saved. The day is changed exactly at this time.

6.5 Handing over the appliance to the owner

The owner of the VRC 430 must be told how to use and operate the controller.

- ⇒ Give the operator the instructions and documentation belonging to the machine for safe-keeping.
- ⇒ Tell the operator the part number.
- ⇒ Tell the operator to store the manuals near the unit.
- ⇒ Go through the operating manual with the operator and answer any questions.

7 Service, warranty

7.1 Vaillant service

To ensure regular servicing, it is strongly recommended that arrangements are made for a Maintenance Agreement. Please contact Vaillant Service Solutions (0870 6060 777) for further details.

7.2 Vaillant warranty

We only grant a Vaillant manufacturer's warranty if a suitably qualified engineer has installed the system in accordance with Vaillant instructions. The system owner will be granted a warranty in accordance with the Vaillant terms and conditions.

All requests for work during the guarantee period must be made to Vaillant Service Solutions (0870 6060 777).

8 Recycling and disposal

9 Technical data

8 Recycling and disposal

Both your VRC 430 and its packaging are primarily made of recyclable raw materials.

Appliance

Neither the VRC 430 nor any of its accessories may be disposed of in the household waste. Make sure the old appliance and any accessories are disposed of properly.

Packaging

Disposal of the transport packaging is undertaken by the expert technician who installed the unit.

9 Technical data

	VRC 430
Operating voltage U _{max}	24 V
Current consumption	< 45 mA
Cross-section connection lines	0.75...1.5 mm ²
Level of protection	IP 20
Protection class	III
Maximum permitted ambient temperature	50 °C
Height mm	97
Width mm	146
Depth mm	45

Table 9.1 Technical specifications VRC 430

Glossary

Set-back temperature

The set-back temperature is the temperature to which your heating lowers the internal temperature to outside the programmed time windows.

Auto_Off (expert technician level)

The "Mode_Auto_Off" menu item in screen C21, "Overall system parameters", is used to determine how the controller behaves when the timer-control is off (i.e. between the "time windows"). The options are Frost protection, ECO and set-back.

- Frost protection

In the times when no time windows are programmed, the boiler is switched off. The frost protection function (see location) is active.

- ECO

In the times when no time windows are programmed, the boiler is switched off. The external temperature is monitored. If the external temperature falls below 3 °C, the target room value reverts to the set-back temperature (minimum 5 °C). This target room value is used as a basis. A frost protection delay time (see location) will affect the start time here. If the external temperature rises above 4 °C, the external temperature continues to be monitored, the boiler is switched off.

- Set-back

In the times when no time window is programmed, the room target temperature reverts to the set-back temperature (minimum 5 °C). This target room value is used as a basis.

Operator level

This is used to display and set/change basic parameters. The parameters can be set/changed by an unskilled operator and during normal operation. The heating system is continuously matched to the requirements of the user by corresponding adjustment of the fundamental parameters.

Operating level for the expert technician

It serves to display and to set/change specific parameters. This level is reserved for the expert technician and is therefore protected by an access code.

Operating mode

Operating modes "Auto" (Automatic), "Manual" and "OFF" are available. You can specify the way in which your room heating and water heating are controlled using the operating modes (see operating instructions Section 4.3.2, Table 4.2).

Frost protection function

The frost protection system protects your heating system and your apartment from frost damage. It remains active in the operating mode "OFF".

The frost protection function monitors the external temperature. If the outside temperature drops below 3 °C, the heating pump switches on for 10 minutes and then off for 10 to 60 min (depends on the outside temperature). If the heating flow temperature is below 13 °C, the burner switches on and controls the room temperature to within 5 °C of the target room temperature. If the external temperature rises above 4 °C, the external temperature continues to be monitored, the heating pump and burner are switched off.

If the outside temperature drops below -20 °C, the burner is switched on and controls the rooms temperature to within 5 °C of the target room temperature.

Frost protection delay time

By setting the frost protection delay time (expert technician level), you can delay the heating control function, which is usually triggered by the frost-protection function (when the outside temperature is 3 °C), for a specified time period (1 - 12 hours).

The frost protection delay setting also works in the "ECO" function in the "Auto_Off" mode (see location). The frost-protection delay time starts when the outside temperature drops below 3 °C.

Heating circuit (HC1)

HC1 indicates heating circuit 1. This refers to your heating system. You can re-name HC1 to something else, if you wish (see operating instructions Section 4.7.5).

Heating curve

The heating curve represents the relationship between external temperature and the flowtemperature. By selecting a heating curve, you can control the flow temperature of your heating system and therefore also the internal temperature.

This option allows to controller, in conjunction with the room switch-on function (see relevant section for details), to adjust to the apartment and heating system. Fig. G.1 shows the possible heating curves for a target room temperature of 20 °C.

If, for example, heating curve 1.5 is selected, a flow temperature of 56 °C is maintained at an external temperature of 0 °C.

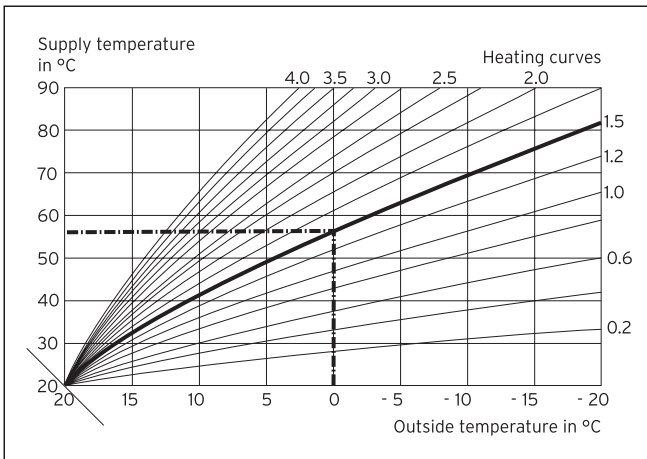

Fig. G.1 Diagram with heating curves for a target room temperature of 20 °C

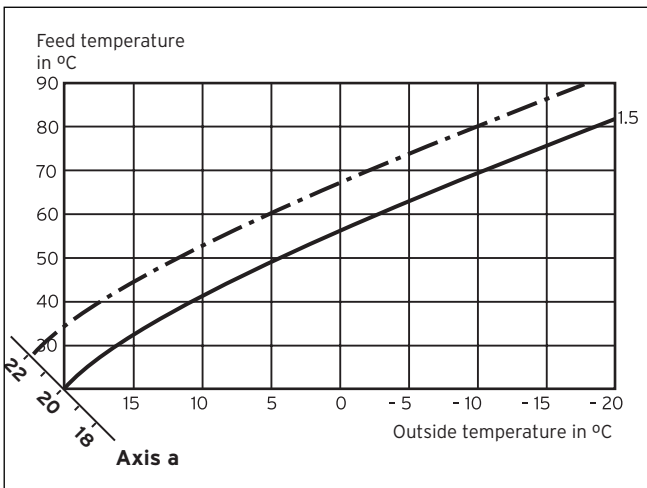

Fig. G.2 Parallel offsetting the heating curve

If you select heating curve 1.5 with a room target temperature of 22 °C rather than 20 °C, the heating curve is displaced as shown in Fig. G.2. The heating curve is displaced in parallel along the 45° axis according to the value of the room target temperature. This means, therefore, if the external temperature is 0 °C, the control system provides a flow temperature of 67 °C.

Heating flow temperature

Your boiler heats water which is pumped through your heating system. The temperature of this hot water as it leaves the boiler is referred to as the flow temperature.

Internal temperature

The internal temperature or room temperature is the actual current temperature in your apartment.

Parameters

Parameters are the properties of your heating system. You can influence these properties by altering the value of a parameter, e.g. changing the "set-back temperature" parameter from 15 °C to 12 °C.

Room switch-on control (expert technician level)

In the screen C8 "HC1 Parameter", in the menu point "Room control" you can decide whether to use the temperature sensor fitted in the VRC 430 or in the remote control unit. To do this the VRC 430 must be wall-mounted and the remote control unit VR 81 must be connected.

The following entries are possible in the menu point "Room switch-on control":

- None

The temperature sensor is not used for control system.

- Switching

The in-built temperature sensor measures the current room temperature in the reference room. This value is compared with the room target temperature and, if there is a difference, the heating flow temperature is adjusted accordingly.

- Thermostat

The built-in temperature sensor measures the current room temperature in the reference room. If the measured value is lower than the room target temperature, the heating flow temperature is increased; if the value is higher than the room target temperature, the boiler is switched off.

The use of the room switching, in combination with careful selection of the heating curve, leads to optimum control system of the heating system.

Target room temperature

The target room temperature is the temperature that you would like in your apartment and which is specified in your controller. Your boiler continues to provide heat until the internal temperature is equal to the target room temperature.

When entering the time programmes, the target room temperature is also referred to as the "comfort temperature".

Target values

Target values are the desired values which you specify to the controller. e. g. the target room temperature or the target temperature for the hot water preparation.

Summer/Winter changeover

In the display screen 1 "Basic Data" in the menu point "Mode selection" you can determine whether the changeover from summer to winter should take place automatically

(Selection: Auto).

The default setting is switches off automatic changeover (Selection: Off).

If the VRC 430 is equipped with the external sensor VRC 9535 which receives the DCF77 time signal, summer/winter changeover takes place automatically; in this case there is no way to switch off the automatic changeover option (Selection: Off).

Flow temperature

See Heating flow temperature.

Hot water generation

Your boiler heats the water in the domestic hot water cylinder to the selected target temperature. If the temperature in the domestic hot water cylinder falls by specific value, the water is heated up again to the target temperature. Time windows can be programmed for hot water generation.

Time window

You can specify three time windows per day for heating, hot water generation and the circulation pump (see operating instructions Section 4.7.1).

Every heating time window is assigned a target value.

The hot water target value is used as a basis for generating hot water (screen 10 "Hot water parameters").

The time windows specify the time for the circulation pump.

In automatic mode the system is controlled as per the specified values in the time windows.

Circulation pump

When you turn on the hot water tap it can take a few moments - depending upon the length of the pipe - before hot water comes out. A circulation pump pumps hot water through the pipes in the hot water circuit. This ensures that hot water is immediately available when you turn on the tap. Time windows can be programmed for the circulation pump.

Vaillant Ltd

Vaillant House ■ Medway City Estate ■ Trident Close ■ Rochester ■ Kent ME2 4EZ
Telephone 01634 292300 ■ Fax 01634 290166 ■ www.vaillant.co.uk ■ info@vaillant.co.uk

0020042468_02 GB 092008